

Aluminum Free standing Dividers

The **Teilen divider** provides privacy in any **health related situations**. Our standard measures of **Free Standing dividers** can easily solve your need of space and protection problems as well as give you durability and flexibility.

- **10 year warranty**
- **No Maintenance Needed**
- **Custom to fit**

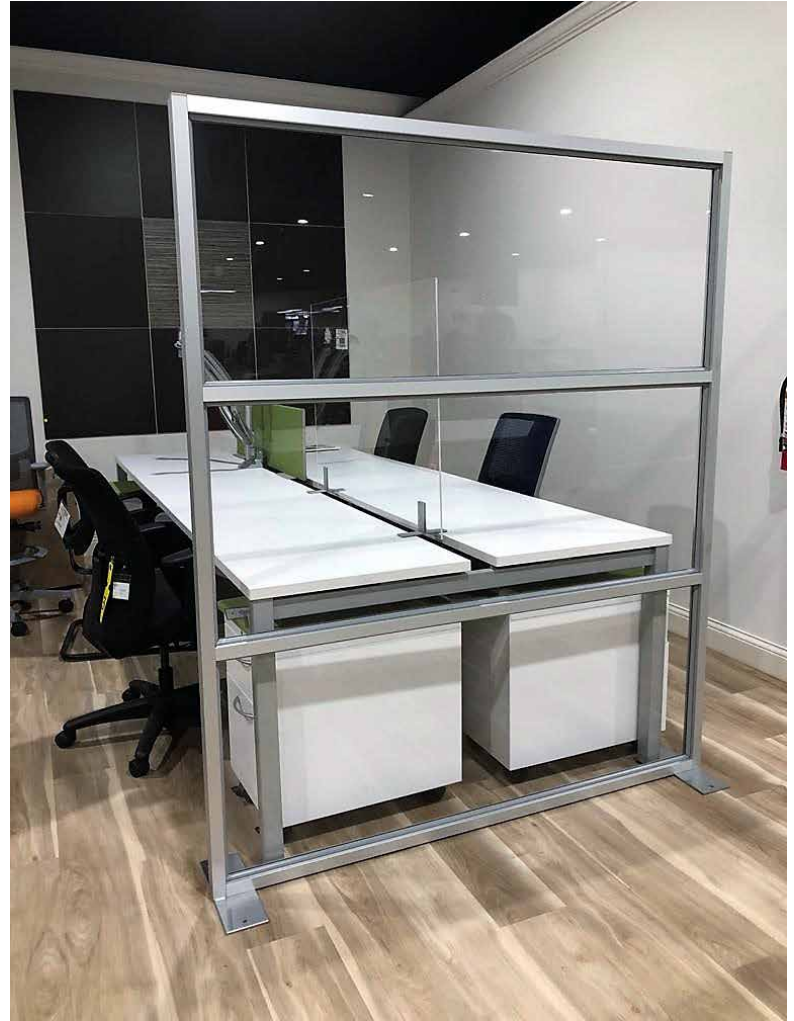



Melamine Free standing Dividers

Teilen System is working hard in this current situation and has designed a **Melamine Free standing dividers** which is more cost effective and still keeps your staff safe from crowded public areas and provides additional **virus protection**.

- Quick installation
- No city permits needed
- Easy to clean



Desk Shield

We have designed a **screen to place** on any desk. The protective wall is efficient against airborne droplets between colleagues and clients, limiting germs and microbes that we are seeing with the **COVID-19** virus. We have 3 different materials Glass, Plexiglass and Polyester Acoustic Panel.

- **Suited to all desk tipe**
- **Enabling visibility**
- **Different materials**
- **Different measurements**

*All Products Solutions are Nationwide delivery.



Aluminum Structure

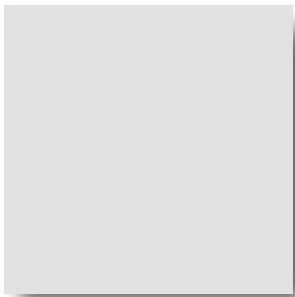

Anodize Silver



Black

Melamine

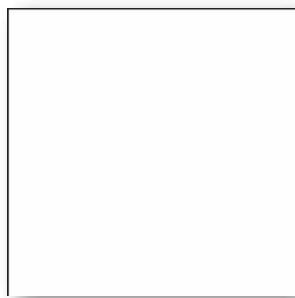

White

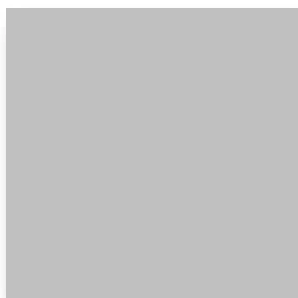

Light gray



Wooden gray



Cappucino

Acoustic Panels

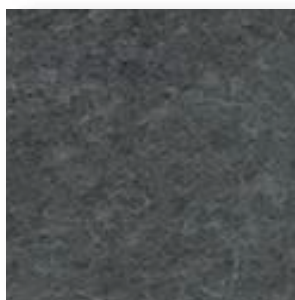

Polyester

Acrylic

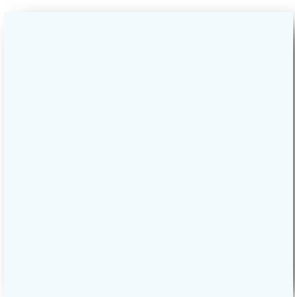

Clear



Frosted

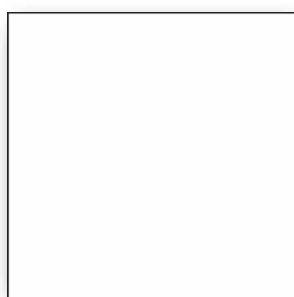

White



Polycarbonate

Aluminum Dividers

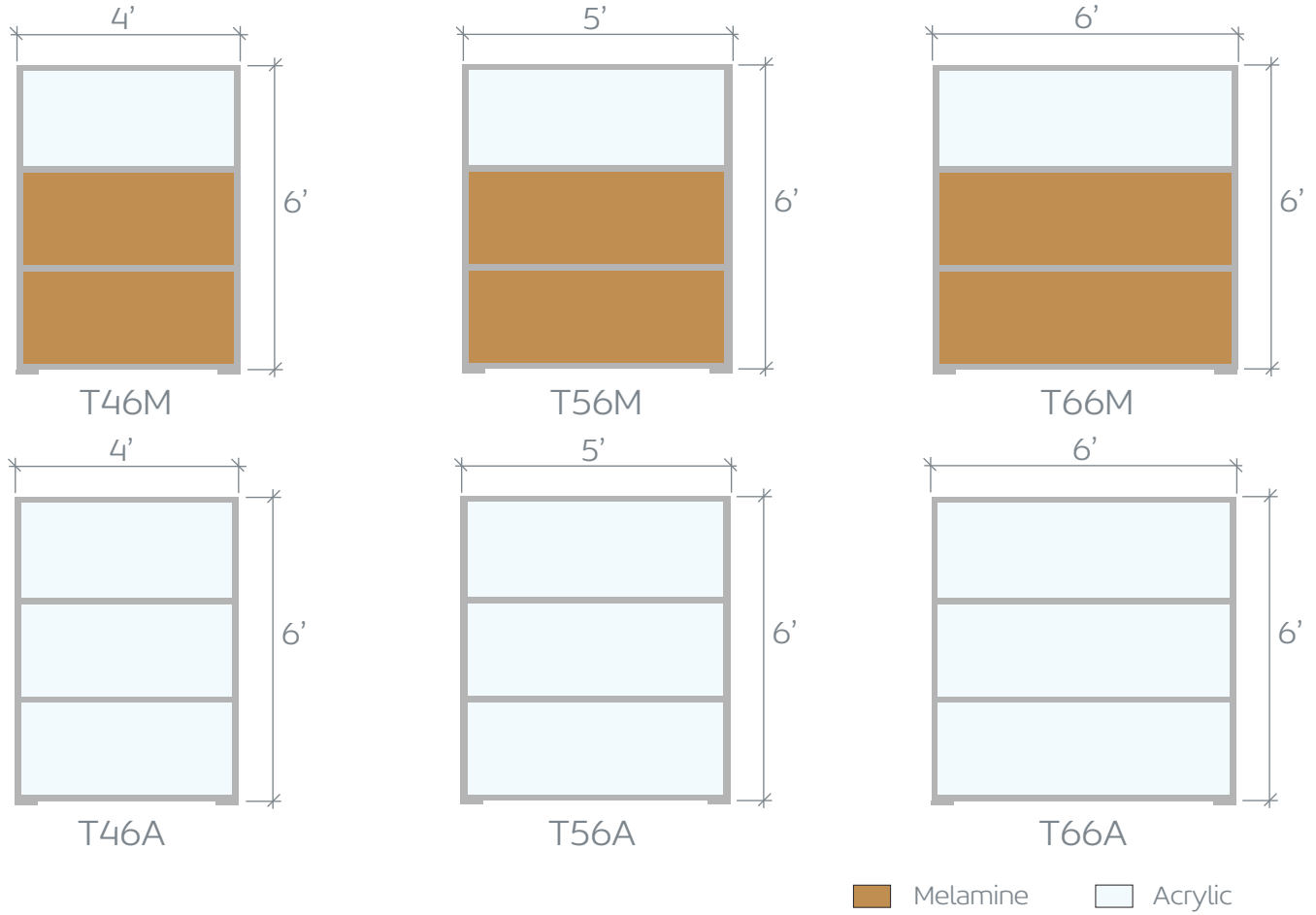

Melamine Dividers

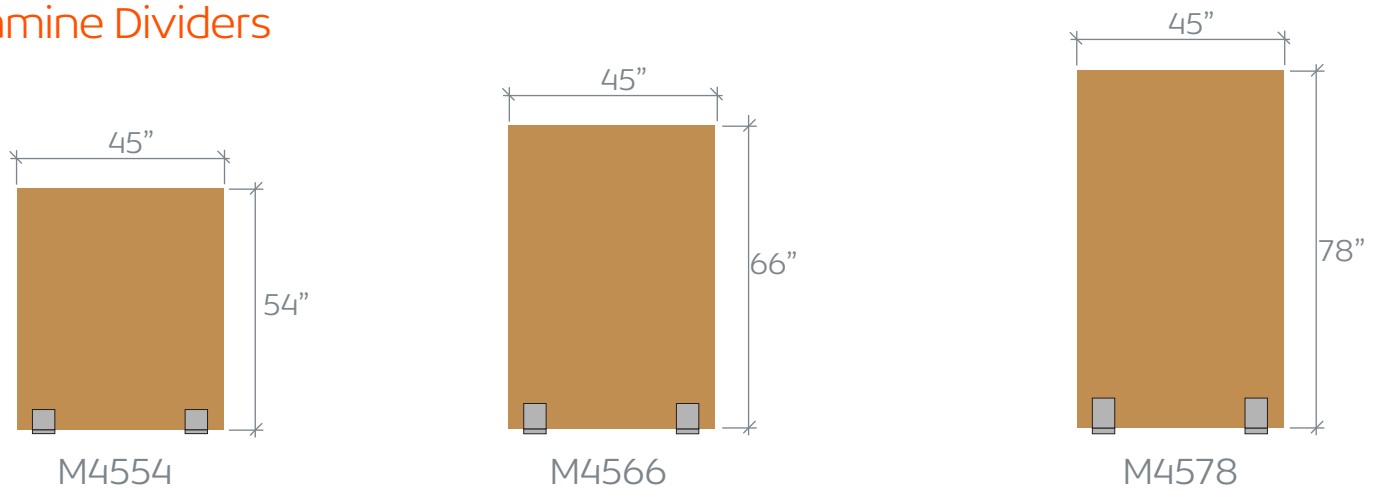

*Melamine Dividers just white and light gray color

Screen Shields

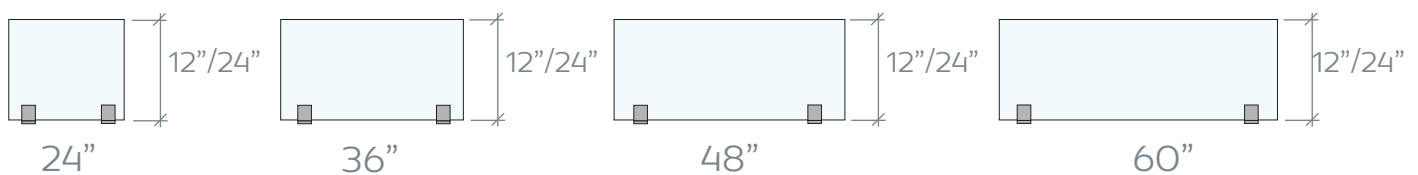

• **Contact one of our dealers for especial price** •

info@teilensystem.com - www.teilensystem.com